

**BTCC-001**

**NÁVOD K OBSLUZE**



**AUTOMOBILOVÁ BLUETOOTH SADA**

## **Funkce**

- Automobilová Bluetooth sada
- Vynikající kvalita zvuku
- Jednoduché použití
- Tři integrované klávesy, pro přijímání hovorů, znovu vytočení a regulaci hlasitosti
- Podporuje hlasové ovládání přijímání a odmítání hovoru pro bezpečnost řízení
- Až 6 hodin hovoru a připravenost k použití i po 600 hodinách bez nabíječky
- Dosah signálu až 10 metrů (za příznivých podmínek)

## **Specifikace**

- Bluetooth v2.1+ EDR
- Frekvenční pásmo: 2.4GHz ~ 2.48GHz nelicencované ISM pásmo
- RF výkon třídy II: pracovní dosah až do 10 m
- Integrovaný přerušovač echa a potlačování hluku
- Vestavěný reproduktor a mikrofon
- Typ baterie: nabíjecí lithium-polymerová baterie 3.7 VDC, 750 mAh
- Nabíjecí čas: až 3 hodiny
- Čas hovoru: až 6 hodin
- Připravenost k použití: více než 600 hodiny bez nabíječky
- Rozměry: 118 x 47 x 15 mm

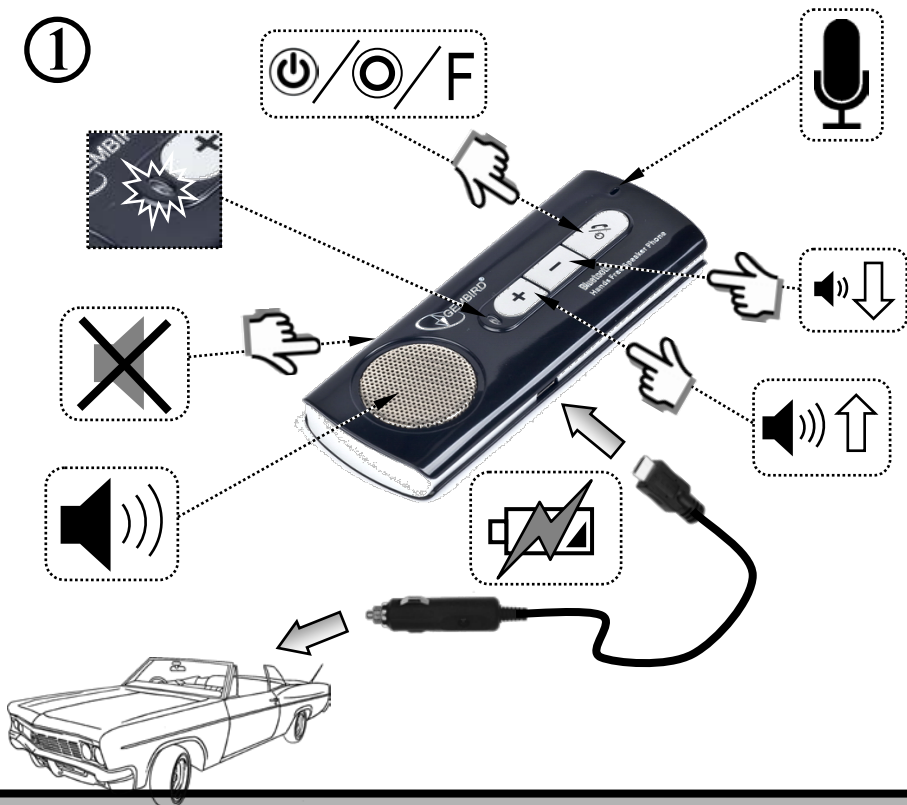
**1**

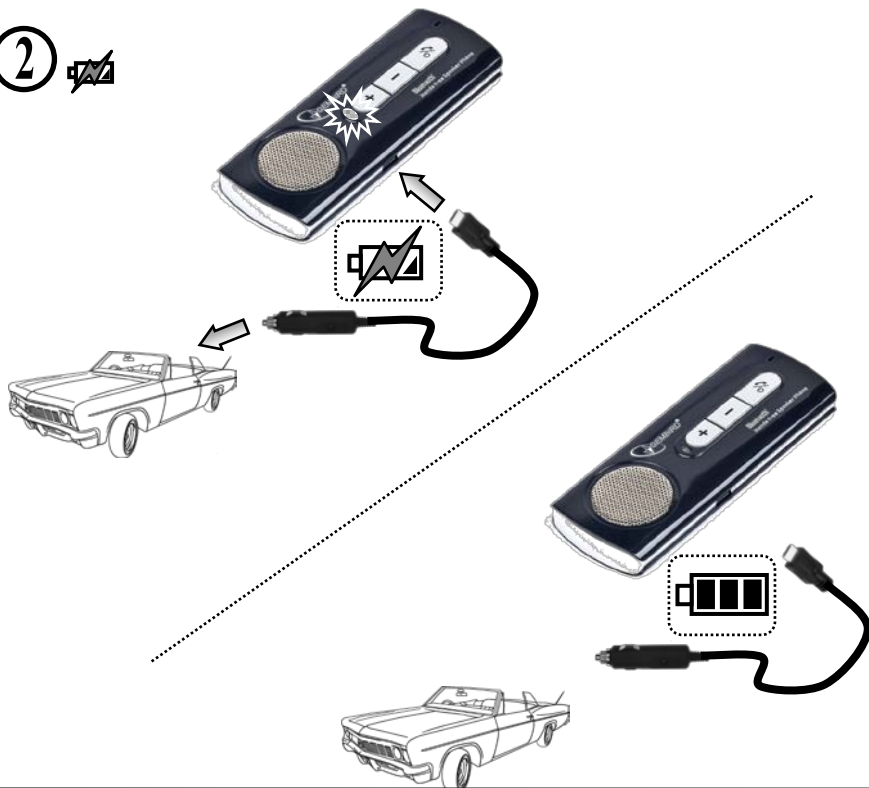
② 

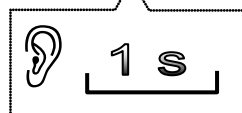
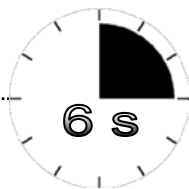
**3**

(Modrá)

(Červená)

(Modrá) (Červená) (Modrá) (Červená) (Modrá) (Červená)

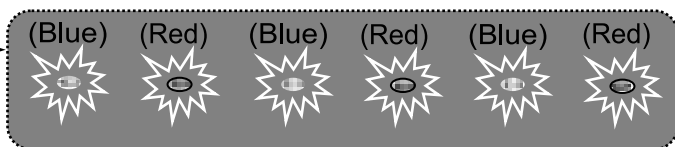

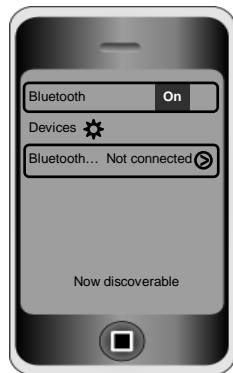
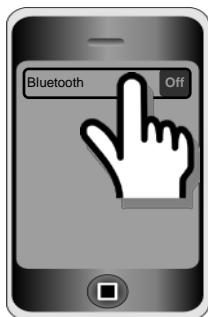
**4**

**5**

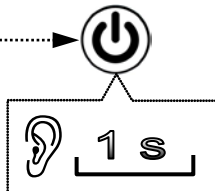

**0000**

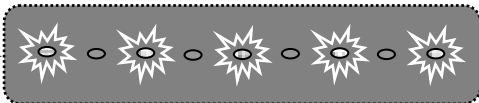
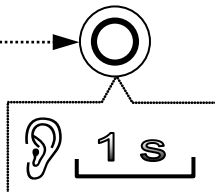
**6** 

(Blue)  
(Modrá)

**7** 

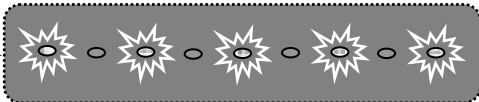
(Red)  
(Červená)



8



9





10



**11**



(Modrá)



(Modrá)/(Červená)

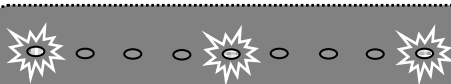

(Modrá)



(Červená)



(Červená)

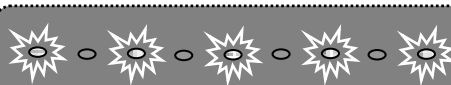

12

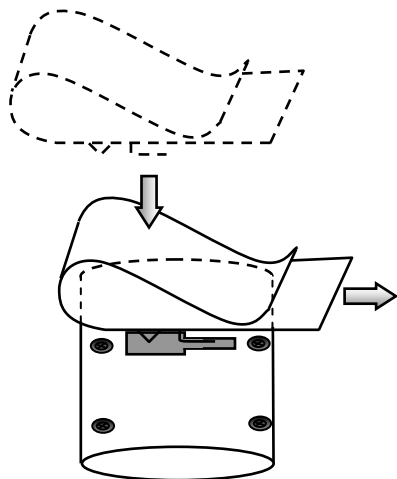

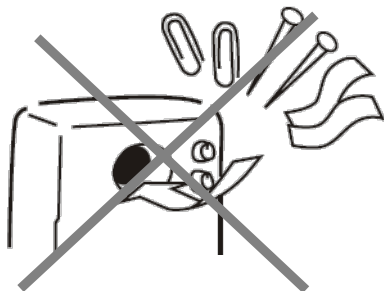

## EC Declaration of Conformity

We hereby certify that the following product complies with all the relevant Safety Requirements of § 4 EMVG and of the Directives 2006/95/EC, 93/68/EEC and 2004/108/EC.

**Applicant :** Gembird Europe BV  
Wittevrouwen 56,  
1358CD, Almere, The Netherlands

**Equipment :** Computer parts

**Model Nos. :** BTCC-001

**Product description :** BTCC-001 Bluetooth v.2.1 + EDR car kit, class II

European standards:

R&TTE ETSI 301489:2002; ETSI 30022:2000; 0 EN60950:2001;

The following manufacturer/WITHIN Europe is responsible for this declaration:

**Gembird Europe BV**  
Wittevrouwen 56, 1358CD, Almere, The Netherlands  
Tel: +31-(0)36-5211588. Fax: +31-(0)36-5347835

\_\_\_\_\_  
Director

The Netherlands / Feb. 2, 2010  
\_\_\_\_\_  
Place and Date

  
\_\_\_\_\_  
Authorized signature

**Likvidace odpadů:**

Nevhazujte toto zařízení společně s domovním odpadem. Nesprávná likvidace může poškodit životní prostředí i lidské zdraví. Informace o sběrných střediscích odpadů a nakládání s použitými elektrickými a elektronickými zařízeními si prosím vyžádejte na místním úřadě nebo u autorizované firmy pro likvidaci elektrických a elektronických zařízení.

**ZMĚNA ÚDAJŮ VYHRÁZENA**